

Capacitors and Filters

Improving power quality for
efficiency and reliability

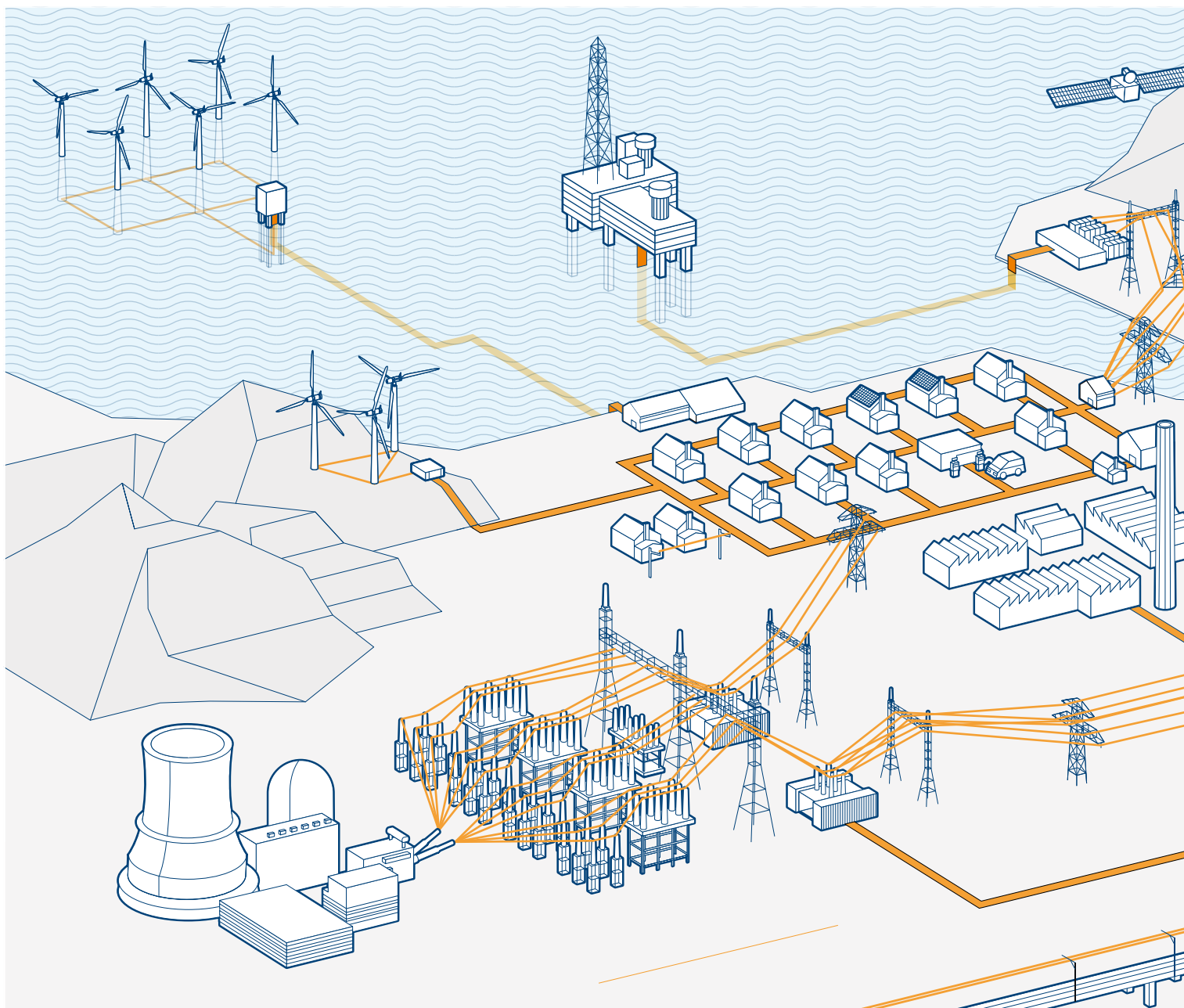

Capacitors are needed in the different parts of the network as part of reactive power compensation and harmonic filtering systems. Mentioned below are the major application areas.

Electrical power transmission and distribution

- Shunt compensation
- Series compensation
- Harmonic filtering
- Static Var Compensation (SVC/STATCOM)
- High Voltage DC transmission (HVDC/HVDC Light)
- Renewable generation (e.g. wind, solar)

Electrical power consumption

- Chemical, Oil and Gas industry (e.g. processing plants, offshore platforms, FPSOs)
- Steel industry (e.g. arc furnaces, rolling-mills)
- Water industry (e.g. pumping stations, desalination plants, waste water treatment plants)
- Commercial building applications (e.g. data centers, office buildings, hotels)
- Transportation industry (e.g. traction, electrical vehicle charging)
- Mining industry
- Process industry (e.g. electrolysis plants)



ABB delivers the full value chain in low, medium and high voltage technologies with a focus on efficient and environmentally-friendly power transport to resources connected to the electrical grid. ABB has been driving development in the field of power quality for over 70 years and been responsible for several important development stages in capacitor and filtering technologies. Some of these developments include:

- The introduction of low voltage dry capacitor technology using metallized plastic film. This technique had the advantage over rival technologies at the time by providing capacitors that were more environmentally friendly, reliable, compact and more energy efficient. As a demonstration of our success and leadership in this field, ABB offers this technology today also for the DC capacitors of HVDC links.
- The introduction of intelligent power factor controllers and fast switching technology allowing precise power factor control under even the most severe conditions and for both slow and fast loads.
- The introduction in the low voltage market of active filter technology for industrial and commercial low voltage applications.
- The implementation of innovative sound attenuation techniques in our high voltage capacitor range, positioning them at the top of what is best available, for the benefit of the environment.

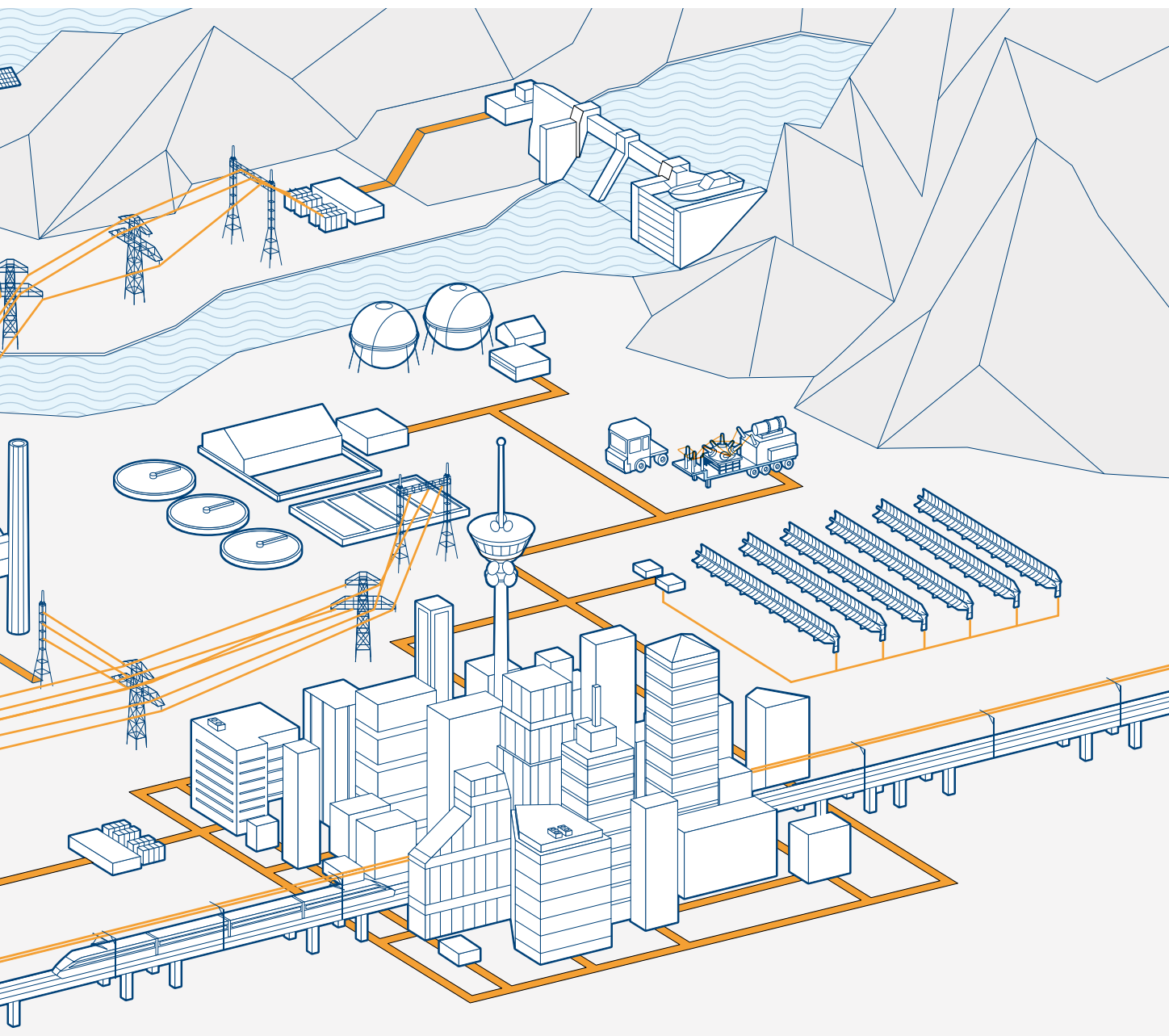
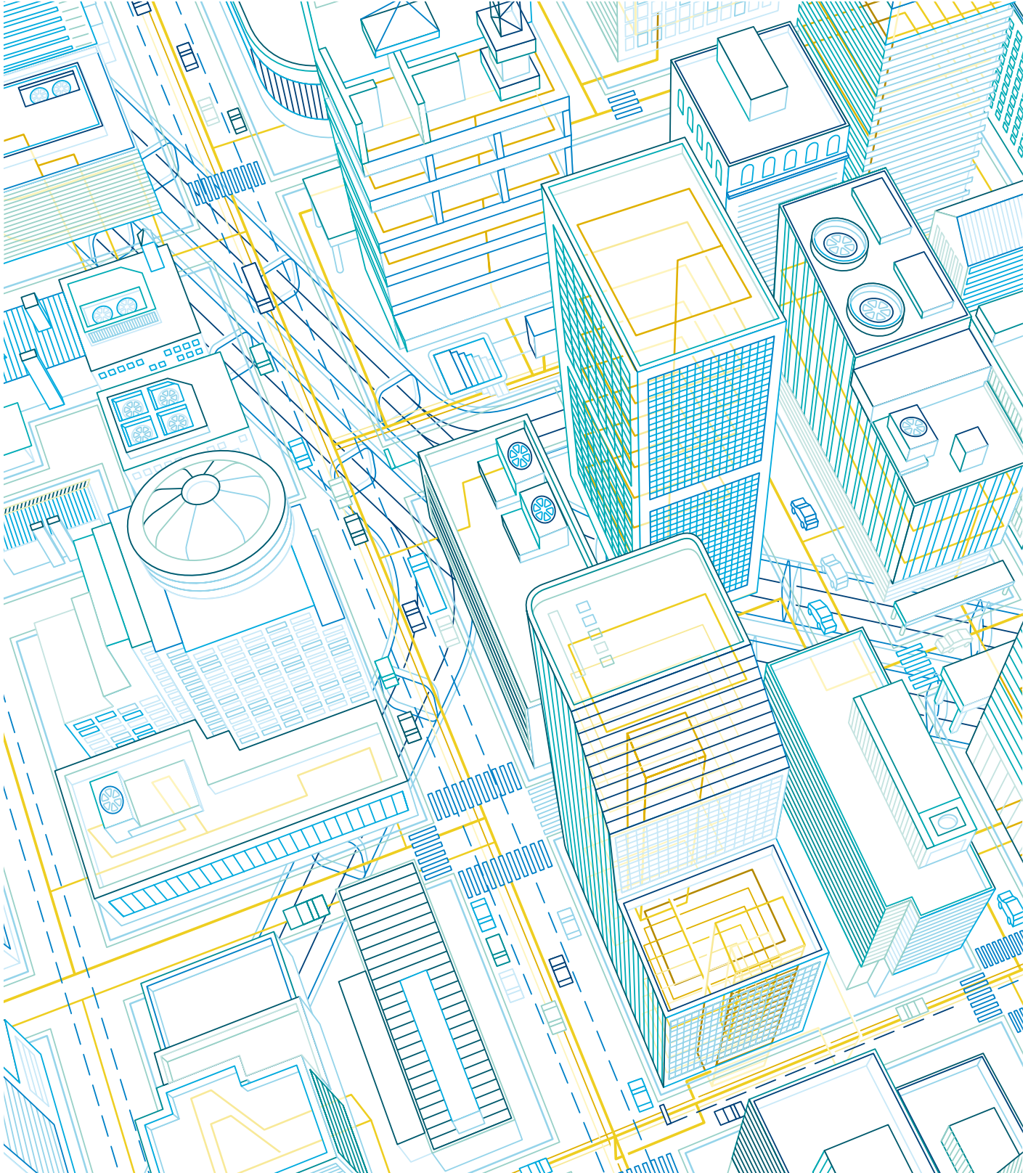

Give your grid a power injection with power capacitors from ABB

Capacitors play an important role

Capacitors are very beneficial in power grids. By producing reactive power, they compensate for the reactive power consumption of electrical motors, transformers, etc.

The results can be seen in the form of more stable power grids with increased transmission capacity and reduced losses thanks to higher power factors.

Capacitors also constitute a key component in the various filter solutions reducing harmonic contents. A non-distorted sinusoidal voltage without harmonics reduces the risk of problems in the form of disturbances in production equipment, metering errors and malfunctions in relay protection. It also extends the service life of connected equipment.

Consumers expect a high quality of supply in order to operate their plants efficiently and generate return on capital. An economic calculation most often shows that a capacitor installation quickly pays for itself. Capacitors play an important role in improving the power quality and ABB's portfolio reflects a wide range of capacitor and electronic solutions spanning all voltage levels for utility and industry applications.

The benefits of good power quality include:

Utilities

- Enhanced asset utilization
- Lower network losses and CO₂ emissions
- Expansion of network capacity
- Voltage stability

Industry

- Reduction of electricity charges
- Lower network losses and CO₂ emissions
- Grid compliance
- Increase in plant capacity
- Higher productivity (i.e. fewer outages, lower operating costs)

A complete program with complete support

ABB's capacitors and capacitor banks are used both in transmission and distribution grids from 208 V to 800 kV. There are filter installations, shunt and series compensating installations, and HVDC transmission systems all over the world, both at power companies and in industries.

As an ABB customer, you gain access to an all-embracing line of capacitors and complete support in the form of analyses, calculations and suggestions on custom solutions for the generation of reactive power and harmonic filtering. Solutions that make it possible to increase active power and reduce disturbances through a smoother sinus form.

Our comprehensive product line, which apart from capacitors also includes all other apparatus for transmission and distribution grids from 380 V to 800 kV, makes us a comprehensive supplier of both individual apparatuses and complete turn-key installations.

ABB's capacitors are used all over the world

Capacitors from ABB have demonstrated their robustness and reliability at power installations all over the world. Our capacitors are designed for reliable operation in all climates, from the arctic cold to the tropical heat.

Portfolio

Below 1000 V

Capacitors
Automatically-switched capacitor banks
Thyristor-switched capacitor banks
Stepless reactive power compensators
Active and passive harmonic filters
Power factor controllers
Active voltage conditioners and industrial UPS systems

Above 1000 V

Power capacitors
Specialty capacitors
Fixed and switched capacitor banks
Passive harmonic filters
Static Var Compensator (SVC)
STATCOM and SVC Light
Series Compensation (SC)
High Voltage DC transmission (HVDC)

Quality and the environment go hand in hand



Production is controlled by strict quality routines

Market-driven research and development are behind ABB's successes in capacitors. The focus has been on developing solutions that provide reliable operation and long service life so as to create the conditions for good operating economy at customers' installations.

Creative engineering and materials development, in combination with modern production technology, constitute the basis for this.

The capacitors are designed for long technical service life, the same as for all ABB apparatuses. Extensive operating experiences show that the failure rate is very low. For you as the customer this means safe operation and low maintenance costs.

Production is controlled by strict quality routines

ABB's capacitors are produced in highly automated workshops, but it is the commitment of our employees that is the determining factor in attaining good final results. A finely tuned quality system with constant checks during all phases of production guarantees high and consistent quality. All capacitor elements are subject to a stringent routine test with test parameters chosen at or above the requirements of applicable international standards. Our ISO 9001 Quality System registration provides the strongest assurance of our product quality.



Process inspection of element winding

Consideration to the environment is a given

One of the primary functions of a capacitor - generating reactive power in order to lower the losses in the network - is in itself an environmentally friendly function. Anyway, all development work at ABB is oriented towards creating environmentally friendly technology. Our capacitors are very advanced in this respect. In addition, we offer dry type capacitors for DC applications. The dry technology has a lower environmental impact compared to conventional impregnated capacitors. ABB's ISO 14001 certification guarantees our commitment to the environment.

We strive to deliver products with optimum quality and accept our responsibility towards future generations by taking account of economic, ecological and social aspects in equal measure. Careful handling of natural resources is thus one of our goals. Minimizing the use of raw materials for production and reducing waste are the other goals. We have implemented procedures for recycling a significant percentage of our waste.



Internal wiring, connection of bushings



Final assembly, mounting of units into racks

Sound damping

Can-type power capacitors emit noise, since the capacitor elements act like loud-speaker membranes. The sound level depends in part on the design of the capacitor and in part on the electrical current spectra through the capacitor.

ABB has developed methods for measuring and predicting noise from power capacitors and can offer different noise reducing measures such as:

- Internal damping (when the current spectra are known)
- External damping with hoods



Nature of the sound and characteristics of its propagation through the atmosphere makes audible noise measurements very complicated and sensitive for external disturbances. The best way of verifying the sound power generated by the source is to measure it in the laboratory.

Reactive power compensation for medium and high voltage



In transmission systems, reactive power is needed to maintain the voltage to deliver active power. A lack of reactive power leads to an inefficient use of the electrical network and results in voltage sags, overloaded transformers, lines, cables etc. In industry motor loads and other electrical loads require reactive power to convert the flow of electrons into useful work.

Open-rack banks, QBANK, for voltages up to 800 kV

QBANK is a flexible concept for open-rack shunt banks and enables very compact solutions that save space at installations based on our HiQ capacitor unit with High Reactive Output. Configuration and power can be varied within a broad span.

QBANK is supplied with internally fused, externally fused or fuseless configurations depending on the bank's voltage and power level. ABB has the expertise needed to engineer an optimal solution for each unique installation.

QBANK is used by customers all over the world. Several years of operating experience and satisfied users testify to the high quality and reliability of HiQ capacitors.

A long-term goal at ABB has been to reduce capacitor losses and to increase the output per volume unit. HiQ capacitors are a result of this development. With HiQ capacitors, we tailor cost-effective and environmentally friendly capacitor banks for reactive power compensation in all types of power grids.

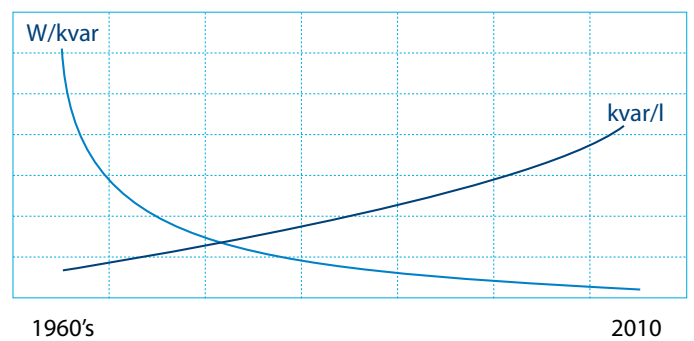

Development of ABB's power capacitors with respect to losses (W/kvar) and power density (kvar/l).



Metal enclosed capacitors and pole-mounted banks

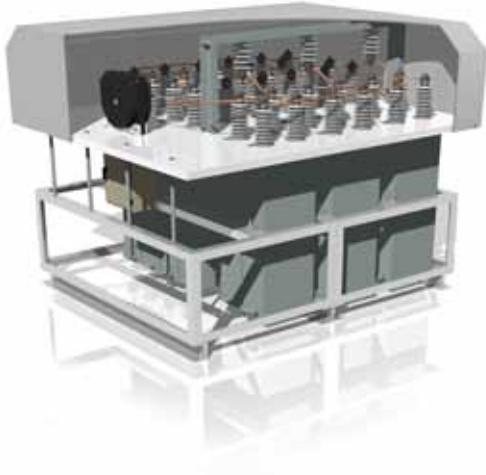

SIKAP



ABBACUS



EMPAC



QPole pole mount capacitor

Metal enclosed capacitor banks

ABB has a range of metal enclosed capacitor banks for a variety of medium voltage applications. The enclosed capacitor bank design enables installation without special fencing. The product range consists of indoor and outdoor solutions, which can be single-step fixed or multi-step switched. They are available from low to high power ratings up to 36 kV. All metal enclosed capacitor banks are delivered completely factory assembled and tested, ready to be secured to the foundation.

SIKAP

The SIKAP enclosed bank is a fully insulated and fixed reactive compensation system for voltages from 4.5 to 24 kV. The enclosure covers the live parts and protects the bank from short-circuits caused by external causes. It also increases personal safety thanks to the compact design and full insulation. SIKAP is easy to locate and requires no fencing or extra protection. The system utilizes the high quality ABB impregnated capacitors with internally fused capacitors with a proven long service life time and low losses. All supplied items are encased by an aluminium cover.

ABBACUS

The ABBACUS combines primary components, secondary control and protection, within a compact modular enclosure. The system can be configured either as a fixed or switched capacitor bank. The switched bank consists of single or multiple steps, automatically controlled to improve the power factor.

The ABBACUS is a packaged reactive compensation system with modular, multi-stage switched capacitor steps that will automatically compensate the network to maintain a preset power factor level. Capacitor stages are switched in and out automatically based on both the power factor and load conditions to ensure that a pre-set target power factor is achieved without risking overcompensation.

Drawing upon ABB's broad product range, most of the primary and secondary components in an ABBACUS are sourced from ABB factories globally (i.e. capacitors, relays, transformers, fuses and switchgear). This ensures customers' peace of mind since the ABBACUS guarantees product quality, reliability, and a global support network.

By supplying customers with fully assembled and factory tested equipment, the ABBACUS minimizes installation and commissioning time. This ensures that valuable customer downtime is reduced and interruption to production is minimal.

ABBACUS shunt banks are available for voltages up to 36 kV.

ABBACUS and SIKAP are based on well-proven technology, and characterized by high reliability and low maintenance costs. The modular design permits the addition of new capacitor units to meet future needs.

The design of the ABBACUS provides compensation for both electrical distribution utilities and large industrial power users, including mining, pulp and paper, chemical, petrochemical, wind farms, plastics and heavy industry.

EMPAC

The EMPAC is a Metal Enclosed Capacitor Bank suitable for voltage ranges of 1 – 36 kV.

The design is ideally suited to reactive compensation for Wind Farm applications, large industrial users and electrical distribution utilities.

The EMPAC is fitted with an earth switch, inrush current limiting reactors, single phase capacitors in a double star configuration with an out of balance protection current transformer.

An optional SF₆ circuit breaker can also be specified.

Pole-mounted banks

The ABB 'Qpole' pole mount capacitor system is an economical solution for shunt reactive compensation on overhead distribution networks.

Pole-mounted banks for voltages up to 36 kV

These pole-mounted banks provide an economical way to apply capacitors to a distribution feeder system, up to 36 kV. The banks provide voltage support, lower system losses, release system capacity and eliminate power factor penalties. ABB can supply various configurations with fixed or switched power and with various control functions. They are factory pre-wired and assembled, ready for installation.

CHARM – Harmonic filtering for medium and high voltage



As electrical consumption increases, demands on availability and high electrical quality are also increasing. It is important that the harmonic content is limited in the supply voltage. ABB's solution for addressing this problem is the CHARM filters.

Development during recent years, however, points to a strong increase in the amount of harmonics in power grids. In industrial grids, harmonics are generated by non-linear loads such as rectifiers, static frequency converters, arc furnaces, etc. Even in distribution networks, harmonics are produced by, for example, computers, switching power supplies and low-energy lamps. Depending on the load type, harmonic pollution levels can exceed 100%, implying that there is more harmonic current in the feeder than at the base frequency. Harmonics can lead to several problems, such as increased losses in machines and apparatuses, control system faults or disturbances in electronics and computers.

Fortunately, the problems can be prevented using suitably adapted harmonic filters consisting of capacitors, reactors, and in some cases, even resistors.

Each installation requires its own solution

Each electrical installation is unique, and to attain optimal filtering, careful analysis and measurement of the harmonic content under various operating conditions are first needed. At ABB, there is substantial experience and expertise in this area, as well as in the engineering and design of suitable filters.

Besides filtering harmonics in grids, the harmonic filter generates reactive power. Harmonic filters can also solve problems with parallel resonance between a grid's inductive and capacitive sections.

Our filters are built with quality products

Our capacitors, as well as our other products for the grid, are produced in some of the world's most modern factories and constitute the building blocks of our filter solution. Other important components of the filters are supplied by carefully selected suppliers, and we can consequently guarantee the highest quality and reliability.

The filter system can be constructed with band-pass filters for filtering a specific frequency, or as high-pass filters that even dampen a wide range of frequencies. Band-pass filters for various frequencies are often combined in the same filter solution.



Low voltage Power Quality products

Power Quality of the low voltage network is an important challenge for today's industrial and commercial applications. Good Power Quality leads to trouble free and efficient operation of installations.

Key elements of plant-related Power Quality problems include:

- Low power factor, as this burdens the supply system unnecessarily and may cause unacceptable voltage drops
- Harmonic pollution, as this causes extra stress in networks and makes installations run less efficiently or not at all
- Load imbalance, as this may lead to an unacceptable voltage imbalance, and leads to an increase of neutral current stress and unacceptable voltage between neutral and earth.

ABB Power Quality products can be used to address these problems in an efficient and optimal way. Two main product classes can be identified.

Power factor correction products

These products give the following benefits:

- Reducing and/or eliminating expensive utility penalties for a low power factor.
- Off-loading of and reduction of power losses in cables and transformers.
- Improving voltage stabilization in your systems and in long cables.
- Reducing CO₂ emissions thanks to the minimization of system losses.

ABB provides a complete range of first class products related to power factor correction.



The manufacturing process of the active filter.

ABB CLMD capacitors

220-1000 V

ABB CLMD capacitors are accepted by customers worldwide as the most reliable, durable and fail-safe dry capacitor available. These features could be attained thanks to ABB's over 60 years experience in dry capacitor technology and thanks to a unique patented sequential protection mechanism. CLMD capacitor units are especially suitable for panel builders and OEMs.



ABB APC capacitor banks

230-690 V

ABB APC contactor switched capacitor banks offer an extensive range of powers and accurate power factor control. The APC banks are supplied as complete units, factory tested and ready for connection. The multiple automatic functions of its ABB controller and user-friendly interface make the APC very easy to commission and operate. Safe and reliable operation in even the harshest environments is ensured thanks to the extensive integrated protection and monitoring functions.



ABB Dynacomps

380-690 V or MV with coupling transformer

ABB Dynacomps are ultra-rapid and transient-free thyristor switched capacitor banks, especially designed to compensate fast variable loads with a low power factor. They are also used to compensate voltage drops caused by large power variations or by operation of varying loads on weak networks. Thanks to their rugged design and state of the art control system, ABB Dynacomps offer key advantages over conventional switched capacitor banks and entry level thyristor switched banks. These are particularly interesting in applications where response speed, transient-free response, repetitive switching and accurate control are needed. ABB Dynacomps have a modular, standardized design which enables easy installation and expansion.



Active filter products, PQF

ABB active filter products PQF are the ultimate answer to tough Power Quality problems caused by harmonics, load unbalance and special requirements of reactive power demand. They are applied in LV systems as well as in MV systems with coupling transformers.

They offer the following benefits:

- Reduced production downtime and/or commercial system downtime.
- Increased system efficiency and reduction of CO₂ emissions.
- Compliance with the strictest Power Quality regulations, thereby avoiding penalties and/or avoiding refusal to connect installations by utilities.
- No detailed network analysis required, rapid implementation of the solution.

The ABB active filter range is suitable for industrial and commercial loads.

208-690 V or MV with coupling transformer

An increasing percentage of loads found in industrial and commercial applications introduce harmonic pollution. Other loads have a capacitive power factor (e.g. blade servers used in data centers) or are unbalanced. All these factors lead to reduced system efficiency and reliability and possibly lead to non-compliance with utility regulations. ABB proposes its active filter range PQF to eliminate these disturbances and render your system more efficient.

They can be used for the smallest to the largest applications in both the industrial and commercial field, for harmonic mitigation, load balancing and step-less reactive power control of both inductive and capacitive loads.



ABB active filters excel thanks to the quality of the control system, making it the most precise and accurate active filter product in the market. Target levels for the power factor and acceptable harmonic limits can be preset. Their un-overloadable, modular concept make them ideal for current installations in which load conditions can change drastically over time.

Capacitors for special applications

ABB provides a range of capacitors for special applications. Our long experience as a supplier of capacitors ensures products that meet the stringent requirements that apply for this type of equipment.

Ripple capacitor

Ripple capacitors are used in high frequency ripple injection plants used to perform load management duties on power supply networks.

The low voltage ripple capacitor, of the type ELKA is used as a tuning capacitor in combination with inductors to generate the appropriate ripple frequency on the transmitter side. The capacitor is single-phased but with multiple taps.

The high voltage ripple capacitor, of the type ELNA is used as a coupling capacitor on the network side to compensate the voltage drop, while transmitting the ripple signal into the network. The capacitor is single-phased and it is floating or has a midpoint connected to the tank. Fundamental frequency is 50 or 60 Hz.

Surge capacitors

The surge capacitor offers the user high transient voltage withstand, long life design, low loss dielectric and rugged construction.

Steep fronted waves (lightning or switching surges) can cause damage to the turn to turn insulation of rotary machines and transformers. These capacitors provide premium surge protection for high voltage motors and generators. They can also be used in combination with surge arresters for added protective capability.

Connecting surge capacitors line to ground at the motor terminals prevents this damage. For a more comprehensive protection scheme, surge capacitors may be used in conjunc-

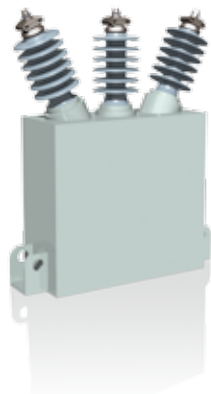

tion with surge arresters. This surge pack modifies both the wave shape and magnitude. Surge capacitors are designed for use in very demanding conditions.

Motor Surge Protection

An encased package with a surge capacitor and lightning arrester. This device provides premium surge protection of high voltage motors and generators with a surge capacitor and station surge arrester combination package. The unit is factory assembled in an outdoor enclosure.

Three-phase capacitors

The three-phase capacitors are characterized by negligible losses and high reliability. The capacitor consists of thin dielectric polypropylene film wound together with electrodes of aluminium foil. Discharge resistors are built-in.

A bio-degradable hydrocarbon compound with excellent electrical properties is used as the impregnation fluid. The container consists of surface-treated high-quality steel and the bushings and terminals are of the highest quality and reliability.

Split-phase capacitor

The ABB split-phase capacitor unit type combines two capacitors in a single housing. The split-phase capacitor units provide an economical double star (Y-Y) unbalance detection scheme using only three units, compared with conventional designs using six units. This is particularly advantageous in low power capacitor banks in fixed, enclosed and pole mount capacitor bank applications. The capacitor unit has three bushings consisting of one common terminal and two capacitor output terminals.

Impregnated capacitor type DC

The ABB capacitors are characterized by negligible losses and high reliability with high quality for advanced systems.

The capacitor consists of thin dielectric polypropylene film wound together with electrodes of aluminium foils. A bio-degradable hydrocarbon compound with excellent electrical properties is used as the impregnation fluid. The container consists of surface-treated high-quality steel and the bushings and terminals are of the highest quality and reliability.

Capacitor accessories

For installation, maintenance, controlling etc., ABB provides a range of high quality accessories for capacitor applications.

Capacitor Lifting Device

The Capacitor Lifting Device tool is easy to operate and facilitates safe handling during the removal and installation of large heavy capacitor units in an open-stack substation bank. The device weighs less than 25 kg and operates on ABB bank designs only. It is typically used with fuseless and internally fused capacitor banks, where the capacitors can weigh up to 100 kg, which the device is rated to handle easily. It includes a rail assembly retaining support, a trolley and winch. One person can operate the device safely and efficiently.

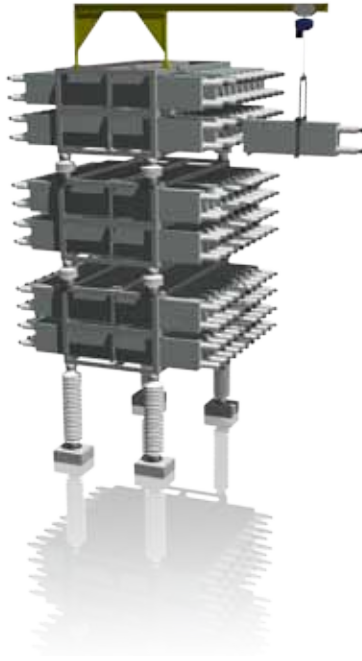

Portable Capacitance Meter, CB-2000

The CB-2000 is an advanced measurement unit especially developed for measurement of capacitances without making any disconnections in the capacitor bank.

The CB-2000 is easy to handle and easy to carry using the shoulder strap. The capacitance value is clearly



shown on the LCD screen, and can be read both in daylight and in dark environments. The measured data can later easily be transferred to and processed in a PC, as the CB-2000 is equipped with a USB port.

The measurement itself is done with the help of a clip-on transformer, which is easily applied on the capacitor bushing and two voltage clips that supply the low-voltage test signal.

The CB-2000 has a measuring range of 0 – 1000 μF and can supply a total load of about 2000 μF .

The capacitance meter is pre-calibrated, complete with clip-on transformer, voltage clips, rechargeable NiMH battery pack, power adapter, extra battery holder, USB stick with software, casing and manual.

Bird Cap

The Bird Cap is the solution to problems caused by accidental contact in HV capacitor banks by e.g. animals. The Bird Cap used together with insulated wiring between capacitor units will increase the insulation sufficiently to avoid the risk of flash-over or short-circuiting in the bank.

Capacitor bank outages and failures are often caused by accidental contact by animals. When the animal touches the HV live parts this can result in a flash-over that can cause unnecessary interruptions or consequential damages to the whole bank.

The Bird Cap is designed to fit all ABB standard bushings. It is easily mounted on the bushings after the connecting wire has been fastened. The Bird Cap is suitable for most climatic conditions, pollution levels and temperatures.



Capacitor accessories

Capacitor Vacuum Switch

The ABB PS vacuum switch is a solid dielectric vacuum switch suitable for use in distribution systems up to 25 kV ungrounded (and 43 kV grounded) for the single phase range. The switch has been specifically designed and tested according to ANSI C37.66 for heavy-duty operation in capacitor-switching applications for the harshest climatic conditions.

With its sleek and compact design, embedded vacuum interrupter technology and durable HCEP insulator, the PS vacuum switch is designed to reduce life cycle costs and offer customers true value. The main housing and highly visible trip lever mechanism is made from stainless steel to provide superior corrosion resistance and durability.



A vacuum is an ideal switching medium. A vacuum provides the dielectric strength required for capacitor switching and an environmentally friendly insulating medium. ABB's range of PS switches utilizes ABB's proven vacuum technology, with over 25 years of experience in developing and manufacturing vacuum interrupters. ABB vacuum interrupters have found applications in other ABB products including automatic circuit reclosers, circuit breakers and contactors.

ABB vacuum interrupters are renowned for their operational reliability and robust construction. The PS vacuum switch is capable of over 50,000 paired fault-free and maintenance-free mechanical switching operations.

The PS vacuum switch is free from any oil, gas or foam insulating mediums, thereby eliminating the risk of any environmental contamination.

Pressure Switch

ABB capacitor units can be fitted with a pressure switch to provide a simple but effective means of protection against excessive pressure within the container.

CQ900 Smart Controller

ABB's CQ900, the next generation in smart controllers, is designed specifically for capacitor applications. They feature an extensive range of control modes including remote, automatic and manual control. The automatic mode includes VAR, time, temperature, power factor, current and/or voltage control, as well as combinations of these. In addition to this, the CQ900 includes measurement and monitoring capabilities and useful features such as a 10,000 event data log for easy analysis and trouble shooting.



The CQ900 is now equipped with communication via the RS232 and Ethernet interfaces which can be used with a wide range of modem devices. The main communication protocol is DNP3.0 with IEC 61850 to follow. The enclosure is designed to allow standard modems to be installed and powered from within.

Introducing ABB SmartLink

The CQ900 has a secure wireless feature allowing local control, interrogation and programming from a linesman's vehicle providing added safety and comfort for operators.

Other desirable features included on the controller are flash upgradeable capability, a neutral current sensing option and test plugs, as well as a large four line LCD screen. The user friendly interface and sizeable keypad allows for easy operation at any time of the day.

A durable IP 54 stainless steel enclosure provides added protection for even the harshest weather conditions and a 450 V metal oxide varistor provides protection for the internal circuit board.

The ABB CQ900 smart controller is an easy-to-use, feature-packed controller designed to offer customers true value through smarter management of their electrical systems and reliable integration with Smart Grid systems.

RVC & RVT Power Factor Controllers:

The PF Controller is an essential component of the PF correction equipment. This user interface plays a key role in the correct and accurate control and monitoring of the power quality.

With its RVC and RVT controllers, ABB proposes the most powerful, complete and user-friendly range available in the market. These devices offer:

- Smart switching strategy, resulting in a fine adjustment of the power factor
- Easy and fast commissioning with an automatic set-up feature
- Measurement and display of key parameters like voltage, current, power factor, THDV and THDI
- Network and bank monitoring with programmable protection threshold
- Event and alarm logging
- Communication features
- Full graphics display
- Multi-language support
- Multi-voltage and multi-frequency



RVC Power Factor Controller



RVT Power Factor Controller

HVDC and FACTS applications



Series capacitors



HVDC capacitors



SVC capacitors

ABB capacitors are used in several utility and industrial power electronic systems. Some examples are given next.

Series capacitors

Series capacitors are installed in transmission systems mainly in order to increase the power transfer capability and to reduce losses by optimizing load distribution between parallel transmission lines.

Series capacitors are also installed in distribution systems. Here, the main reason is to improve the voltage stability of the network.

Series compensation of a network positively affects the voltage and reactive power balance. When the load current passes through the capacitor, the voltage drop over the capacitor varies in proportion to the current. The voltage drop is capacitive, e.g. it compensates the inductive voltage drop, which also varies with the load current. The result is an automatic stabilizing effect on the voltage in the network.

Simultaneously, series capacitors generate reactive power, the power factor in the network is improved, whereby the line current and the line losses are reduced and the load capacity is increased. The generated reactive power varies proportionally to the square of the load current. Thus, the reactive power is automatically regulated.

SVC capacitors

In Static Var Compensation (SVC) thyristors are used for switching and control of capacitors and reactors. Instant transient-free switching is attained, as well as continuously variable control of the reactive power.

SVCs in transmission systems increase their capacity, improve voltage control and stability, and damp power swing due to network faults or tripping of heavy loads in interconnected systems. They are also used in distribution systems and for difficult loads, e.g. arc furnaces, where asymmetrical fluctuations in the current occur due to the instability of the consumption of the arc.

Fluctuations in the current resulting in variations in the consumption of reactive power can be controlled and the furnace is provided with more active power, thus increasing productivity.

HVDC capacitors

Extensive research in advanced DC capacitor technique along with operation experience since 1954 makes ABB the world's most experienced supplier of HVDC capacitors.

Technical ratings depend on application. Please contact ABB with your specific needs.

Power capacitors form an important part of an HVDC transmission system for filtering of harmonics and supply of reactive power. The high quality and reliability are essential to the overall performance of the system. ABB uses self-protected capacitors in HVDC applications. The self-protected capacitors can be either of a patented fuse-less design or equipped with internal fuses. The self-protected design offers advantages of vital importance for all applications where high reliability is an absolute necessity, as in HVDC systems.

Single element failures do not affect the performance and protection coordination is easier, enabling increased selectivity compared to other protection solutions.

ABB Capacitors has a long history of working together with both ABB HVDC and FACTS to jointly develop more efficient network solutions.

STATCOM and SVC Light

The ABB STATCOM and SVC Light products use power semiconductors to control the exchange of Mvar over a shunt connection with the grid. Thanks to the fast and transient-free controllability, these products can counteract even the most rapid voltage transients that will appear in the grid and consequently reduce the risk of serious voltage sags and/or voltage collapse.

Additionally they can under steady state conditions, through continuous control of reactive power injection or absorption, control the grid voltage profile according to a given optimal characteristic.

The benefits for the grid owner/operator are that the stability limit dictated by system voltage will be raised and that the voltage profile will be more controlled. The grid capacity will be enhanced at the same time as its behavior will be more robust, flexible and predictable.



For the consumer of electric power, the optimization of an existing power system can increase productivity, reduce energy costs and increase the reliability of the system.

Contact us

Please contact your local sales representative for further information.

www.abb.com

www.abb.com/powercapacitors

©Copyright 2010 ABB. All rights reserved

NOTE! ABB is working continuously to improve the products. We therefore reserve the right to change designs, dimensions and data without prior notice.

Publication THSM 9543 31-01en, Edition 1, 2010-11 Capacitors and Filters, Improving power quality for efficiency and reliability Photo: Hesse Eriksson, Mats Findell